

WALCO

MERCURIO
BASIC [⊥]
BASIC [⊐]
LIBA
ICOR
DOMINO EVO
DERA
HERMES
LIBRA
TIPPER
SPOT
ALFA PLUS
DERA PLUS
VELA
SISTEMA
LOGICA

WALCO

AT WORK

**MERCURIO – BASIC ¹ – BASIC ⁿ – LIBA – ICOR – DOMINO EVO – DERA
HERMES – LIBRA – TIPPER – SPOT – ALFA PLUS
DERA PLUS – VELA – SISTEMA – LOGICA**

intro

2

Il catalogo "At Work" offre soluzioni modulari per tutti i tipi di uffici, grandi o piccoli, operativi o direzionali, per open space o domestici. Qualsiasi sia l'ambiente di lavoro, le proposte Walco permettono di arredare gli spazi in modo funzionale e organizzato, dando risposte ergonomiche, componibili e flessibili, a tutte le funzioni che quotidianamente si svolgono negli ambienti di lavoro. Così da avere sempre la massima libertà funzionale che si sposa con la capacità di esprimere al massimo il proprio stile nell'arredare lo spazio, grazie alla grande flessibilità creativa.

The catalog "At Work" offers modular solutions for all types of offices, big or small, operative or executive, for open spaces or domestic ones. Whatever the working environment, Walco's proposals make it possible to furnish spaces in a functional and organized way, providing ergonomic, modular and flexible responses to all the functions that are performed every day in the workplace. So as to always have maximum functional freedom that goes hand in hand with the ability to fully express one's own style in furnishing the space, thanks to great creative flexibility.

Le catalogue "At Work" propose des solutions modulaires pour tous les types de bureaux, grands ou petits, opérationnels ou de direction, pour les espaces ouverts ou domestiques. Quel que soit l'environnement de travail, les propositions de Walco permettent de meubler les espaces de manière fonctionnelle et organisée, en apportant des réponses ergonomiques, modulaires et flexibles à toutes les fonctions qui sont exercées quotidiennement sur le lieu de travail. Afin d'avoir toujours une liberté fonctionnelle maximale qui va de pair avec la capacité d'exprimer pleinement son style dans l'ameublement de l'espace, grâce à la grande flexibilité créative.

3

MERCURIO

4

Rappresenta l'essenzialità del posto di lavoro nell'ufficio operativo moderno. Scrivanie per tutte le esigenze con fianchi pannellati o gambe cilindriche. Sono disponibili ventidue finiture in melaminico per liberare la fantasia e rendere l'ambiente gradevole e personalizzato.

It represents the essentiality of the workplace in the modern operative office. Desks for all needs with paneled sides or cylindrical legs. Twenty-two melamine finishes are available to free the imagination and make the environment pleasant and personalized.

Il représente l'essentiel du lieu de travail dans le bureau opérationnel moderne. Des bureaux pour tous les besoins avec des côtés lambrissés ou des pieds cylindriques. Vingt-deux finitions en mélamine permettent de libérer l'imagination et de rendre l'environnement agréable et personnalisé.



5



Scrivania / Desk /
Bureaux:
Metallo Grigio
M927 Rovere Gessato

Ark light:
M790
Grafite

Ark Pensili / Wall units /
Hauts:
M790 Grafite

Scrivania / Desk / Bureaux:
Metallo Grigio
M953 Noce Mat

Ark Pensili / Wall units / Hauts:
M953 Noce Mat



8

9

BASIC [⊥]

10

Basic [⊥] fa della semplicità il suo punto forte. Linee pulite e leggere si combinano ai tanti colori disponibili del piano e alle tante modalità compositive, dando spazio alla creatività. Questa scrivania si caratterizza per la gamba a "T" rovesciata su cui poggia il piano in melaminico con spessore di 25 mm. Una struttura solida ma ariosa, che può essere sagomata o dritta, può accompagnarsi a dattilo laterale, cassettiere, pannelli frontali, screen sospesi e molti altri accessori.

Basic [⊥] makes simplicity its strong point. Clean and light lines combine with the many available colors of the top and the many compositional methods, giving space to creativity. This desk is characterized by the inverted "T" leg on which the 25 mm thick melamine top rests. A solid but airy structure, which can be shaped or straight, can be accompanied by a lateral typist, drawer units, front panels, suspended screens and many other accessories.

Basic [⊥] fait de la simplicité son point fort. Des lignes épurées et légères se combinent avec les nombreuses couleurs disponibles du plateau et les nombreuses méthodes de composition, laissant place à la créativité. Ce bureau se caractérise par le pied en "T" inversé sur lequel repose le plateau en mélaminé de 25 mm d'épaisseur. Une structure solide mais aérée, qui peut être façonnée ou droite, peut être accompagnée d'une dactylographe latérale, de blocs-tiroirs, de façades, d'écrans suspendus et de nombreux autres accessoires.



11

L'ufficio si colora di verde grazie alla possibilità di inserire nell'arredamento la fioriera Flora, sovrapposta all'Orgatower oppure al contenitore Robin. Per un tocco di privacy in più, possono essere installati gli screen sospesi con o senza funzione fonoassorbente.

The office is colored in green thanks to the possibility of inserting the Flora planter into the furniture, superimposed on the Orgatower or the Robin container. For a touch of extra privacy, suspended screens can be installed with or without sound-absorbing function.

Le bureau se colore de vert grâce à la possibilité d'insérer la jardinière Flora dans le meuble, superposée à l'Orgatower ou au conteneur Robin. Pour une touche d'intimité supplémentaire, des écrans suspendus peuvent être installés avec ou sans fonction d'absorption acoustique.



12

13

Scrivania / Desk / Bureaux
Metallo Bianco
M840 Corten Berico

Screen sospeso / Suspended screen panel
/ Panneau suspendu
F550 Verde Siria
Flora
M840 Corten Berico
Robin
MO01 Bianco

Cassettiera / Pedestal / Caisson à tiroirs
Metallo Bianco

Job - Sedia / Chair / Chaise
Scocca Bianco
Tessuto C335

BASIC ¹

WALCO

BASIC [□]

14

Basic [□] si connota per la gamba dalla tipica forma a "U" rovesciata. Si tratta di una soluzione per gli ambienti di lavoro operativi che permette di creare diverse disposizioni, grazie ai tanti colori disponibili della scrivania e alle varie modalità compositive degli elementi. Il piano in melaminico con spessore di 25 mm poggia sulla trave che può essere anche agganciata con apposite staffe direttamente su componenti come l'Orgatower e/o sul contenitore Robin. La scrivania Basic [□] può essere sagomata o dritta, con o senza dattilo laterale, cassettiere, pannelli frontali, screen sospesi e molti altri accessori.

Basic [□] is characterized by the typical inverted "U" shaped leg. It is a solution for operational workspaces that allows you to create different arrangements, thanks to the many colors available for the desk and the various compositional methods of the elements. The melamine top with a thickness of 25 mm rests on the beam which can also be hooked with special brackets directly on components such as the Orgatower and / or on the Robin container. The Basic [□] desk can be shaped or straight, with or without side typing, drawer units, front panels, suspended screens and many other accessories.

Basic [□] se caractérise par la jambe en forme de "U" inversé typique. C'est une solution pour les environnements de travail opérationnels qui vous permet de créer différents agencements, grâce aux nombreuses couleurs disponibles sur le bureau et aux différentes méthodes de composition des éléments. Le plateau en mélaminé d'une épaisseur de 25 mm repose sur la poutre qui peut également être accrochée avec des supports spéciaux directement sur des composants tels que l'Orgatower et / ou sur le conteneur Robin. Le bureau Basic [□] peut être façonné ou droit, avec ou sans dactylographie latérale, blocs-tiroirs, façades, écrans suspendus et de nombreux autres accessoires.



15

Scrivania / Desk / Bureaux
Metallo Bianco
M955 Rovere Maine

Pannello fonoassorbente / Sound
absorbing panel / Panneau
insonorisant
Tessuto 1008

Cassettiera / Pedestal /
Caisson à tiroirs
M001 Bianco

Job - Sedia / Chair /
Chaise
Scocca Bianco
Tessuto D802

Orgatower
M001 Bianco
Flora
M955 Rovere maine

Composizioni a due scrivanie, con Orgatower laterale nella duplice funzione di mobile d'archiviazione e sostegno per le travi che supportano il piano. Per una maggior privacy, tra le scrivanie, è stato installato uno screen sospeso imbottito.

Compositions with two desks, with lateral Orgatower in the dual function of storage furniture and support for the beams that support the top. For greater privacy, a padded suspended screen has been installed between the desks.

Compositions avec deux bureaux, avec Orgatower lateral a la double fonction de meuble de rangement et de support pour les poutres qui soutiennent le plateau. Pour plus d'intimité, un paravent capitonné suspendu a été installé entre les bureaux.



LIBA

20

Liba è una proposta operativa dalle linee rigorose e dall'animo versatile. Una scrivania di spessore, che fa del gioco tra angoli, sospensioni e materiali la sua caratteristica distintiva. Si connota per la gamba in metallo squadrata 50x50 mm e la doppia trave a sostegno del top in melaminico. Liba è una scrivania modulare e componibile, disponibile lineare o sagomata, con appoggio su profilo metallico oppure su mobili di servizio di differenti dimensioni.

Liba is an operational proposal with rigorous lines and a versatile soul. A thickness desk, whose distinctive feature is the play between corners, suspensions and materials. It is characterized by the 50x50 mm squared metal leg and the double beam supporting the melamine top. Liba is a modular and sectional desk, available linear or shaped, with support on a metal profile or on service units of different sizes.

Liba est une proposition opérationnelle aux lignes rigoureuses et à l'âme polyvalente. Un bureau important, dont la particularité est le jeu entre angles, suspensions et matières. Il se caractérise par le pied carré en métal de 50x50 mm et la double poutre supportant le plateau en mélaminé. Liba est un bureau modulaire et modulable, disponible linéaire ou en forme, avec support sur un profilé métallique ou sur des unités de service de différentes tailles.



21

Scrivania / Desk / Bureaux
Metallo Nero
M955 Rovere Maine

Screen sospeso / Suspended
screen panel / Panneau suspendu
F660 Polvere

Ark
M955 Rovere Maine
M001 Bianco

Orgatower
M 790 Grafite
Dobby
M955 Rovere Maine

Flora
M955 Rovere Maine

Kappa - Sedia / Chair /
Chaise
Scocca Nera
Tessuto C38T



Scrivania / Desk / Bureaux
Metallo Nero
M790 Grafite

Ark Scorrevole
M001 Bianco

Kappa - Sedia / Chair / Chaise
Scocca Nera
Tessuto D429

Scrivania / Desk / Bureaux
Metallo Nero
M955 Rovere Maine

Mobili di servizio / Service base
units / Meubles de rangement
M955 Rovere Maine
F660 Polvere

Ark
M955 Rovere Maine
F660 Polvere

Pannello fonoassorbente a terra
/ Ground sound-absorbing panel
/ Panneau insonorisant au sol
Tessuto 1012

Joy - Sedia / Chair / Chaise
Scocca Nera
Tessuto C38T



28

LIBA



29

WALCO

Scrivania / Desk / Bureaux
Metallo Ocra
M011 Corda

Screen sospeso rivestito /
Suspended upholstered screen
panel / Panneau suspendu
revêtu
Tessuto D809

Cassettiere / Pedestal
/ Caisson à tiroirs
M011 Corda

Ark
M011 Corda
F132 Ocra

Pannello fonoassorbente a terra
/ Ground sound-absorbing panel
/ Panneau insonorisant au sol
Tessuto 1012

Kappa - Sedia / Chair / Chaise
Scocca Nera
Tessuto D809

ICOR

32

Icor in veste operativa si dota di tutti i confort e gli strumenti utili per rendere sempre pratico e funzionale l'ambiente di lavoro. I mobili di servizio su cui poggiano lateralmente le scrivanie, fungono anche da separatori delle aree, oltre che essere comodi spazi d'archiviazione. Per Icor sono disponibili cassettiere, pannelli frontali, screen sospesi e tanti altri accessori come ad esempio il portamonitor, singolo o doppio.

In an operational capacity, Icor equips itself with all the comforts and useful tools to make the work environment always practical and functional. The service furniture on which the desks rest laterally also act as separators for the areas, as well as being convenient storage spaces. For Icor are available drawer units, front panels, suspended screens and many other accessories such as the monitor holder, single or double.

À titre opérationnel, Icor se dote de tout le confort et des outils utiles pour rendre l'environnement de travail toujours pratique et fonctionnel. Les meubles de service sur lesquels reposent latéralement les bureaux servent également de séparateurs d'espaces, en plus d'être des espaces de rangement pratiques. Pour Icor sont disponibles des blocs-tiroirs, des panneaux avant, des écrans suspendus et de nombreux autres accessoires tels que le support de moniteur, simple ou double.



33

Scrivania / Desk / Bureaux
Metallo Nero
M965 Rovere Rigato

Screen sospeso / Suspended
screen panel / Panneau
suspendu
FO95 Nero Intenso

Mobili di servizio / Service base
units / Meubles de rangement
F222 Giallo sole
M965 Rovere Rigato
M001 Bianco

Ark Scorrevole
M001 Bianco
K095 Nero Intenso

Kappa - Sedia / Chair / Chaise
Scocca Nera
Tessuto D430

Klint Trapuntato - Divano / Sofa / Canapé
Tessuto C50F

34

35

Scrivania / Desk / Bureaux
Metallo Nero
M990 Calce Cenere

Ark
M011 Corda
M965 Rovere Rigato

Kikka - Sedia / Chair / Chaise
Scocca Bianco
Tessuto D430

DOMINO EVO

38

Domino Evo riprende un classico Walco e ne attualizza stile e funzionalità. Resta la solida struttura in metallo con gambe 50x50 mm e traversi, entrambi di sezione quadrata, disponibili nei colori bianco, nero e grigio. Il piano della scrivania può essere in nobilitato con spessore 18 mm, oppure in vetro con spessore 12 mm. Colori, finiture di pregio e una grande varietà compositiva, oltre ai tanti accessori disponibili, la rendono una scrivania di grande prestigio.

Domino Evo takes up a classic of Walco and updates its style and functionality. The solid metal structure remains with 50x50 mm legs and crosspieces, both with a square section, available in white, black and gray color. The desk top can be in melamine with an 18 mm thickness, or in glass with a thickness of 12 mm. Color, fine finishes and a great variety of compositions, in addition to the many accessories available, make it a desk of great prestige.

Domino Evo reprend un classique de Walco et met à jour son style et ses fonctionnalités. La structure métallique solide reste avec des pieds et des traverses de 50x50 mm, tous deux de section carrée, disponibles en blanc, noir et gris. Le plateau du bureau peut être en mélamine d'une épaisseur de 18 mm, ou en verre d'une épaisseur de 12 mm. La couleur, les finitions soignées et une grande variété de compositions, en plus des nombreux accessoires disponibles, en font un bureau de grand prestige.



39

Scrivania / Desk / Bureaux
Metallo Nero
M790 Grafite

Scrivania / Desk / Bureaux
Metallo Nero
M955 Rovere Maine

Screen sospeso rivestito
/ Suspended upholstered screen
panel / Panneau suspendu revêtu
D41R

Orgatower
M790 Grafite
Flora
M011 corda

Ark
M790 Grafite
M955 Rovere Maine

Fysika - Sedia / Chair / Chaise
Scocca Nera
Tessuto A29F

Klint Trapuntato - Divano
/ Sofa / Canapé
Tessuto C50F



40

41



Tavolo / Table / Tableau
Metallo Nero
M839 Marmo Nero Marquina
V095 Vetro Nero Intenso

Ark
M782 Antracite

Kappa - Sedia / Chair / Chaise
Tessuto D806

DERA

44

Dera prevede tra le sue composizioni anche la possibilità di far poggiare il piano su mobili di servizio dalla grande profondità, che quindi assolvono con efficacia anche alla funzione d'archiviazione, oltre che di sostegno della scrivania. Per Dera sono previste tante finiture di pregio con cui poter scegliere il piano di lavoro: effetti legno, ma anche effetti materici, tinte unite opache o piani in vetro laccato temperato.

Among its compositions, Dera also includes the possibility of placing the top on service units with great depth, which therefore effectively perform the function of archiving, as well as supporting the desk. For Dera there are many fine finishes with which to choose the worktop: wood effects, but also material effects, lacquered tops or tempered lacquered glass tops.

Parmi ses compositions, Dera inclut également la possibilité de placer le dessus sur des unités de service avec une grande profondeur, qui remplissent donc efficacement la fonction d'archivage, ainsi que de soutenir le bureau. Pour Dera, il existe de nombreuses finitions raffinées avec lesquelles choisir le plan de travail : effets bois, mais aussi effets de matière, plateaux laqués ou plateaux en verre laqué trempé.



45



Tavolo / Table / Tableau
Metallo Bianco
M947 Noce Smoke



Ark
M001 Bianco
F680 Oceano

Kappa - Sedia / Chair / Chaise
Scocca Nera
Tessuto C388

Dera è una scrivania le cui travi possono essere agganciate con apposite staffe agli Orgatower e ai contenitori Robin.

Dera is a desk whose beams can be attached with special brackets to the Orgatower and Robin storage units.

Dera est un bureau dont les poutres peuvent être accrochées avec des supports spéciaux aux conteneurs Orgatower et Robin.



48



49

DERA

WALCO



DERA

La boiserie si trasforma in pratica parete attrezzata, grazie alla cremagliera orizzontale che permette di installare mensole e pensili.

The panel is transformed into a practical equipped wall, thanks to the horizontal rack that allows you to install shelves and wall units.

La boiserie se transforme en un cloison équipé pratique, grâce à la crémaillère horizontale qui permet d'installer des étagères et des éléments hauts.



WALCO



52

53

Scrivania / Desk / Bureaux
Metallo Bianco
M943 Frassino Nuvola

Screen sospeso rivestito
/ Suspended upholstered
screen panel / Panneau
suspendu revêtu
Tessuto 1012

Mobili di servizio
/ Service base units
/ Meubles de rangement
F680 Oceano

Cassettiera / Pedestal
/ Caisson à tiroirs
Metallo Bianco

Ark
M943 Frassino Nuvola
Ark Scorrevole
M001 Bianco

Boiserie
F052 Ghiaia
G680 Oceano

Yoyo - Sedia / Chair / Chaise
Scocca Bianca
Tessuto D809

HERMES

54

Hermes è una scrivania regolabile in altezza che facilita l'ergonomia della postazione di lavoro e segue le esigenze di chi la usa: progettare, scrivere o costruire, qualsiasi funzione sarà agevolata, grazie all'altezza ottimale impostata. Il meccanismo elettrico permette la regolazione indipendente e la possibilità di memorizzare fino a quattro posizioni, il piano di lavoro si regola facilmente in un attimo. Hermes è un sistema pratico per far diventare il luogo di lavoro un ambiente dinamico, capace di adattarsi ai differenti usi e all'altezza di ciascun utente.

Hermes is a height-adjustable desk that facilitates the ergonomics of the workstation and follows the needs of those who use it: design, write or build, any function will be facilitated, thanks to the optimal height setting. The electric mechanism allows for independent adjustment and the possibility to memorize up to four positions, the worktop is easily adjusted in an instant. Hermes is a practical system for making the workplace a dynamic environment capable of adapting to different uses and to the height of each user.

Hermes est un bureau réglable en hauteur qui facilite l'ergonomie du poste de travail et suit les besoins de ceux qui l'utilisent : concevoir, écrire ou construire, toute fonction sera facilitée, grâce à la hauteur optimale réglée. Le mécanisme électrique permet un réglage indépendant et la possibilité de mémoriser jusqu'à quatre positions, la surface de travail peut être ajustée facilement en un instant. Hermes est un système pratique pour faire du lieu de travail un environnement dynamique, capable de s'adapter aux différentes utilisations et à la taille de chaque utilisateur.



55

Scrivania / Desk / Bureaux:
Metallo Bianco
M965 Rovere Rigato

Ark:
M965 Rovere Rigato
F550 Verde Siria
M001 Bianco

Logica:
M001 Bianco
F660 Polvere

Ark scorrevole:
M001 Bianco
M965 Rovere Rigato

Cassettiera / Pedestal
/ Caisson à tiroirs:
Metallo Bianco

56

57

Scegliere l'altezza di Hermes è facile e pratico usando il frontalino. Basta un gesto e la scrivania si regola all'altezza desiderata senza alcuno sforzo.

Choosing the height of your Hermes is easy and practical. Just one touch on the front panel and the desk adjusts to the desired height, without any effort.

Choisir la hauteur de Hermes est facile et pratique. Depuis la façade, il su t d'un geste et le bureau se règle à la hauteur désirée, sans aucun effort.



58

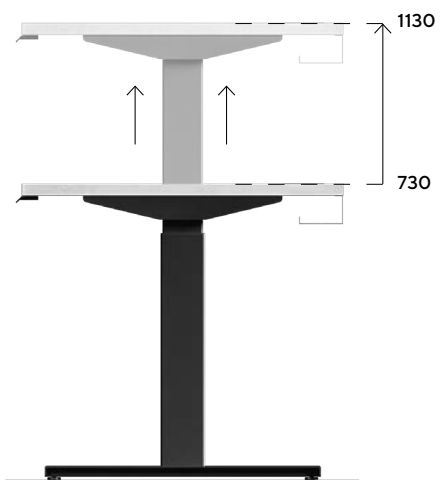

Estensione 1 elemento
730=1130

1 element extension
730=1130

Extension à 1 élément
730=1130

HERMES



59

WALCO

LIBRA

60

Due tavoli uniti da un'unica struttura in metallo ma regolabili in altezza in modo indipendente, questo è Libra, il bench con canalizzazione centrale e pannelli divisorii fissi opzionali. Libra pone in perfetto equilibrio la condivisione dello spazio di lavoro con i colleghi e le esigenze del singolo, ogni tavolo può essere regolato in autonomia, grazie al meccanismo elettrico che rende semplice e rapido il cambio di altezza adattandosi alla statura di chi lo usa e alla funzione richiesta.

Two tables joined by a single metal structure but adjustable in height independently, this is Libra, the bench with central cable management and optional fixed divider screens. Libra provides the perfect balance between sharing workspace with colleagues and the needs of the individual; each table can be adjusted independently, thanks to the electric mechanism which makes the change of height simple and quick, adapting to the height of the user and the function required.

Deux tables unies par une seule structure métallique mais réglables en hauteur indépendamment, c'est Libra, le banc avec canalisation centrale et panneaux de séparation fixes en option. Libra met en parfait équilibre le partage de l'espace de travail avec les collègues et les exigences de l'individu, chaque table peut être réglée indépendamment, grâce au mécanisme électrique qui rend le changement de hauteur simple et rapide, s'adaptant à la stature de l'utilisateur et à la fonction requise.



61



62

63

Scrivania / Desk / Bureaux:
Metallo Nero
M965 Rovere Rigato

Ark light:
M001 Bianco
F660 Polvere

Ark light:
M001 Bianco
F550 Verde Siria

Orgatower:
M001 Bianco
M965 Rovere Rigato

Screen:
F075 Grigio Caldo

LIBRA

WALCO

TIPPER

64

Il tavolo con piano a ribalta TIPPER è una soluzione smart per gli spazi lavorativi multifunzione. La sua grande flessibilità lo rende perfetto per allestire nello stesso ambiente una sala riunioni, un'aula, un meeting o un ufficio operativo open space, in tempi rapidissimi e senza cambiare l'arredamento presente. Le ruote e il sistema di chiusura del piano permettono di accatastare tra loro più elementi in pochissimo spazio e di spostare il tavolo in modo rapido. Sicuro, grazie alle maniglie blocca-sblocca e alle ruote pivotanti con freno.

The TIPPER drop-leaf table is a smart solution for multifunctional workspaces. Its great flexibility makes it perfect for setting up a meeting room, classroom, meeting or open space operational office in the same environment, in very rapid themes and without changing the decor present. The wheels and the closing system of the top allow you to stack several elements together in very little space and to move the table quickly. Safe, thanks to the lock-unlock handles and pivoting wheels with brakes.

La table rabattable TIPPER est une solution "smart" pour les espaces de travail multifonctionnels. Sa grande flexibilité le rend parfait pour aménager une salle de réunion, une salle de classe, une réunion ou un bureau opérationnel en open space dans le même environnement, dans des thèmes très rapides et sans changer le décor présent. Les roulettes et le système de fermeture du plateau permettent d'empiler plusieurs éléments ensemble dans très peu d'espace et de déplacer la table rapidement. Sûr, grâce aux poignées verrouillables et aux roues pivotantes avec freins.



65



66



TIPPER



67



WALCO



68



TIPPER



69

WALCO

SPOT

70

Il tavolo SPOT sfrutta il sistema innovativo con cui è progettata la gamba pieghevole. Leggera e pratica, non ha struttura centrale e permette di essere chiusa completamente all'interno del piano. Ideale per allestire in pochissimo tempo un ambiente, risulta pratico ed efficiente in contesti come meeting, conferenze e banchetti. Le caratteristiche della gamba ripiegabile permettono di accatastare tra loro i tavoli che, leggeri e pratici, possono essere impilati e spostati con il carrello portatavoli.

The SPOT table exploits the innovative system with which the folding leg is designed. Light and practical, it has no central structure and allows it to be closed completely inside the top. Ideal for setting up an environment in a very short time, it is practical and efficient in contexts such as meetings, conferences and banquets. The characteristics of the folding leg allow the tables to be stacked together which, light and practical, can be stacked and moved with the trolley.

La table SPOT exploite le système innovant avec lequel le pied pliant est conçu. Léger et pratique, il n'a pas de structure centrale et permet de le refermer complètement à l'intérieur du plateau. Idéal pour créer un environnement en très peu de temps, il est pratique et efficace dans des contextes tels que réunions, conférences et banquets. Les caractéristiques du pied pliant permettent d'empiler les tables qui, légères et pratiques, peuvent être empilées et déplacées avec le chariot.



71





SPOT è pratico e veloce da assemblare. Alzando le leve si ruota di novanta gradi la gamba, una volta aperta e posizionata, si richiude la leva che blocca e rende stabile e sicuro il tavolo.

SPOT is practical and quick to assemble. By lifting the levers, the leg is rotated ninety degrees, once opened and positioned, the lever closes and makes the table stable and safe.

SPOT est pratique et rapide à monter. En soulevant les leviers, la jambe est tournée à quatre-vingt-dix degrés, une fois ouverte et positionnée, le levier se ferme et rend la table stable et sûre.



Con il sistema di agganci Spot-coppia è possibile unire tra loro più tavoli senza l'uso di riduttori o ulteriori accessori. Basta aprire il gancio presente in ciascun tavolo, affiancare i piani e quindi chiudere tra loro i due ganci.

With the Spot-couple coupling system, it is possible to join several tables together without the use of reducers or additional accessories. Just open the hook on each table, place the tops side by side and then close the two hooks together.

Avec le système de couplage Spot-couple, il est possible de joindre plusieurs tables entre elles sans utiliser de réducteurs ou d'accessoires supplémentaires. Il suffit d'ouvrir le crochet de chaque table, de placer les plateaux côte à côte puis de refermer les deux crochets ensemble.



ALFA PLUS

76

Con la serie Alfa Plus lo spazio di lavoro si trasforma in un ambiente esclusivo dove, grazie alle tante combinazioni, è possibile dar vita a composizioni dallo stile personalizzato. L'ampia scrivania con fianchi pannellati può essere indipendente oppure poggiare su mobili di servizio con gonna pannellata o su travi metalliche. Uno dei tanti dettagli di classe è il distanziale in alluminio con finitura cromata che disegna e sottolinea il profilo dei vari elementi che compongono la scrivania.

The Alfa Plus series transforms workspace into an exclusive environment where, thanks to the many combinations, arrangements can be created and customized in terms of style. The large desk with paneled sides can be freestanding or rest on service units with a paneled skirt or on metal beams. One of the many classy details is the aluminum spacer in chrome finish, which designs and emphasizes the profile of the various elements making up the desk.

Avec la série Alfa Plus, l'espace de travail se transforme en un environnement exclusif où, grâce aux nombreuses combinaisons, il est possible de créer des compositions au style personnalisé. Le grand bureau avec côtés lambrissés peut être indépendant ou s'appuyer sur des meubles desserte avec une panneau arrière ou sur des poutres métalliques.

L'un des nombreux détails de classe est l'espaceur en aluminium avec une finition chromée qui dessine et souligne ainsi le profil des différents éléments qui composent le bureau.



77

78



ALFA PLUS

79



WALCO



80

La gonna pannellata è lavorata con taglio diagonale, dando un tocco di leggerezza e movimento al disegno complessivo. La collezione Alfa Plus si completa con elementi come il tavolo riunione, il tavolino ribassato e le scrivanie dattilo che possono essere aggregabili a 90° o indipendenti.

The paneled skirt features a diagonal cut, which brings a touch of lightness and movement to the overall design. The Alfa Plus series is completed with elements such as the circular meeting table, the low coffee table and typing desks, which can be joined at 90° or freestanding.

Le panneau arrière est travaillé à coupe diagonale, donnant une touche de légèreté et de mouvement à l'ensemble. La série Alfa Plus est complétée par des éléments tels que la table de réunion, la table basse et les tables dactylo pouvant s'y ajouter à 90° ou indépendants.

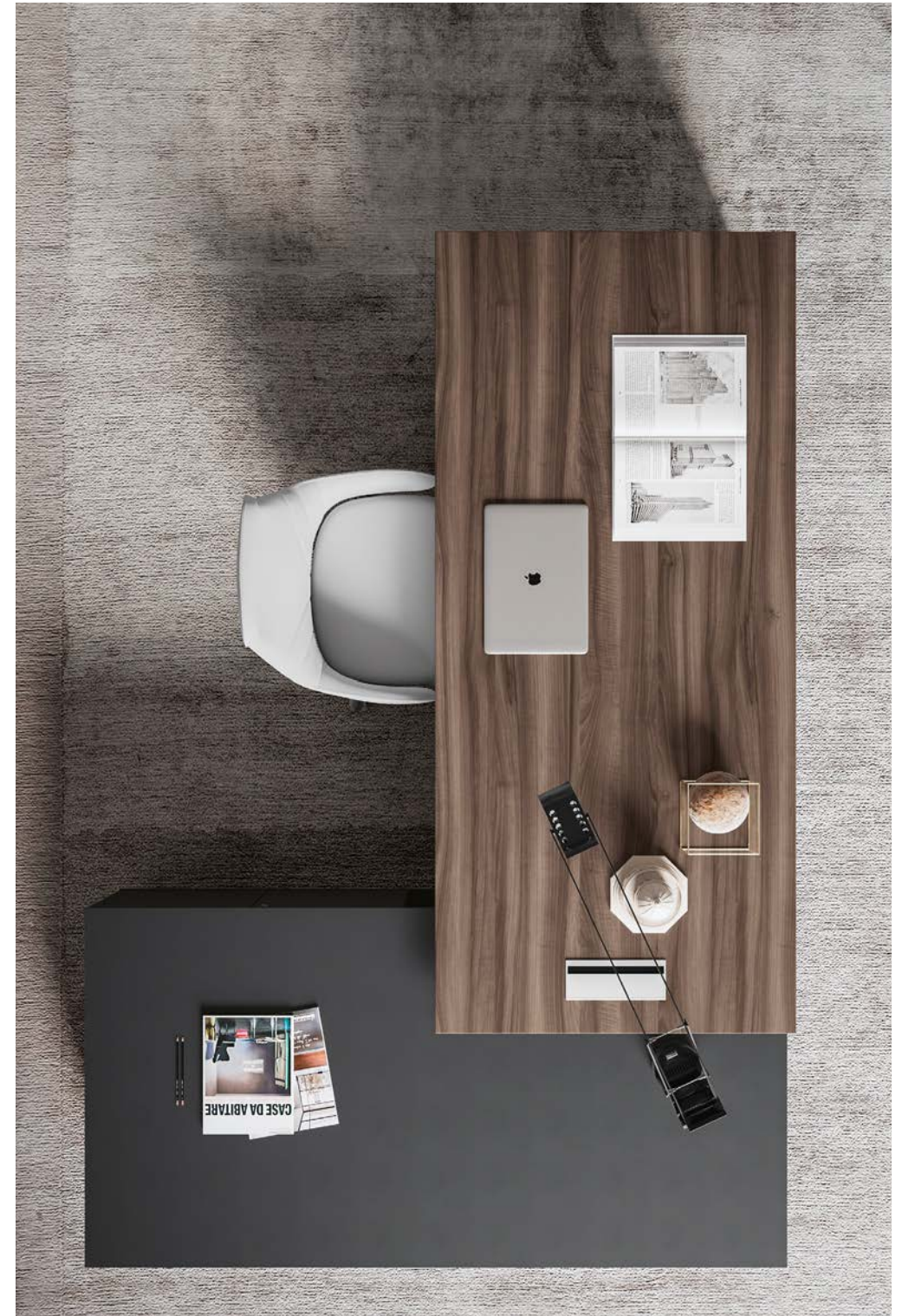

81

DERA PLUS

82

Dera Plus si distingue per la finitura cromata della struttura con gambe ad anello chiuso e piedini regolabili di serie. La finitura cromata da alla scrivania uno stile minimalista dal gusto contemporaneo. I piani possono essere in nobilitato melaminico con spessore 18, 25, o 40 mm, e possono poggiarsi su mobili di servizio di grande profondità con funzione d'archivio. Il piano può essere anche in vetro temperato extrachiaro retrolaccato con spessore 12 mm.

Dera Plus stands out due to the chrome finish of the structure which features closed-ring legs, with adjustable feet as standard. The chromed epoxy powder coating gives the desk a minimalist style with a contemporary taste. The tops can be made of melamine in 18, 25, or 40 mm thicknesses, and can be placed on extra deep service units that serve as storage. The top can also be made of 12 mm thick extra-clear back-lacquered tempered glass.

Dera Plus se caractérise par la finition chromée de la structure avec des pieds de table à anneau fermé et des pieds réglables en standard. La finition chromé confère au bureau un style minimaliste au goût contemporain. Les plateaux peuvent être en mélaminé avec une épaisseur de 18, 25 ou 40 mm, et ils peuvent s'appuyer sur des meubles de service très profonds avec une fonction d'archivage. Le plateau peut également être en verre trempé extra-clair rétrolaqué d'une épaisseur de 12 mm.



83



DERA PLUS



WALCO



La collezione Dera Plus è disponibile nelle versioni scrivania con mobile di servizio, scrivania indipendente e tavolo riunioni. La struttura della gamba è disponibile nei colori nero e cromo.

The Dera Plus series is available in the versions: desk with service unit, independent desk and meeting table. The leg structure is available in the colors black and chrome.

La série Dera Plus est disponible dans les versions bureau avec meuble desserte, bureau indépendant et table de réunion. La structure du pied de table est disponible dans les couleurs noir et chrome.



VELA

88

Vela è un programma di scrivanie direzionali versatile e moderno che permette di accostare in maniera equilibrata i diversi elementi che lo compongono. Le scrivanie sono caratterizzate da due tipologie di piani, uno in melaminico con sottopiano laccato, l'altro in vetro acidato e da varie combinazioni di colonne circolari e fianchi elettrificabili. Disponibili elementi come sottomano, pannelli di chiusura laterali e particolari delle colonne rivestiti in pelle per conferire personalità e unicità.

Vela is a versatile and modern executive desk program that allows you to combine the various elements that make it up in a balanced way. The desks are characterized by two types of tops, one in melamine with a gray lacquered undercounter, the other in etched glass and various combinations of circular columns and electrifiable sides. Available elements such as desk pads, side closing panels and elements of the columns covered in leather to give personality and uniqueness.

Vela est un programme de bureau de direction polyvalent et moderne qui vous permet de combiner les différents éléments qui le composent de manière équilibrée. Les bureaux sont caractérisés par deux types de plateaux, l'un en mélaminé avec un comptoir laqué gris, l'autre en verre dépoli et différentes combinaisons de colonnes circulaires et de côtés électrifiables. Les éléments disponibles tels que les sous-main, les panneaux de fermeture latérale et les éléments des colonnes recouverts de cuir confèrent personnalité et originalité.



89



90

91

Day - Scrivania / Desk / Bureaux:
M953 Noce Mat
K106 Beige lucido

Kimera - Poltrona / Armchair / Fauteuil:
Tessuto P905

Di gradevole impatto estetico l'accostamento con sportelli e sottomano rivestiti in pelle.

The combination with leather-covered doors and desk pads is a pleasant aesthetic.

La combinaison avec des portes recouvertes de cuir et des tablettes de bureau confère une esthétique agréable.



92

VELA

Colonna esagonale rivestita in pelle con piastre cromate e supporti metallici verniciati a polveri.

Hexagonal column covered in leather with chrome-plated plates and powder-coated metal supports.

Colonne hexagonale recouverte de cuir avec des plaques chromées et des supports métalliques peints en poudre.



93

WALCO



94

95

VELA

WALCO

Day - Scrivania / Desk / Bureaux:
Vetro acidato
F150 Brown Opaco

Klivia - Poltrona / Armchair / Fauteuil:
Tessuto P903



Nest - Scrivania / Desk / Bureaux:
M927 Rovere Gessato
F052 Ghiaino Opaco

Kimera - Poltrona / Armchair
/ Fauteuil:
Tessuto A38F



98

99

Due sono le forme dei piani disponibili. Uno particolare nella forma, l'altro, qui rappresentato, dalla forma semplice e rigorosa.

There are two forms of plans available. One particular in the form, the other, represented here, with a simple and rigorous form.

Il existe deux formes de plans disponibles. L'un en particulier dans la forme, l'autre, représenté ici, avec une forme simple et rigoureuse.

Tavolo riunione circolare per quattro ospiti. Le colonne esagonali, con basamento cromato, possono essere in finitura laccata opaca oppure rivestite in pelle

Circular meeting table for four guests. The hexagonal columns, with chromed base, can be in matt lacquered finish or covered in leather

Table de réunion circulaire pour quatre invités. Les colonnes hexagonales, avec base chromée, peuvent être en finition laquée mat ou recouvertes de cuir.





102



103

Idea - Tavolo / Table / Tableau:
M943 Frassino Nuvola
F052 Ghiaia Opaco

VELA

WALCO



Il programma Vela prevede varie forme e dimensioni di tavoli riunione, con e senza elettrificazioni, con piani in melaminico oppure in vetro acidato.

The Vela program includes various shapes and sizes of meeting tables, with and without electrifications, with melamine or etched glass tops.

Le programme Vela comprend différentes formes et tailles de tables de réunion, avec ou sans électrification, avec des plateaux en mélamine ou en verre dépoli.



Soluzioni per tutte le esigenze con tavoli riunione da inserire in spazi confortevoli oppure minimal.

Solutions for all needs with meeting tables to be inserted in comfortable or minimal spaces.

Des solutions pour tous les besoins avec des tables de réunion à insérer dans des espaces confortables ou minimaux.



108

109

Nest - Tavolo / Table / Tableau:
F550 Verde Sira
Vetro Acidato

Ark:
M927 Rovere Gessato

SISTEMA

110

Il concept Sistema permette di arredare lo spazio ricettivo in modo personalizzato, grazie alla modularità dei tanti elementi che lo compongono. Pannelli di chiusura laterali e centrali, contenitori laterali o centrali, angolo contenitori interni ed esterni, assieme a mensole, cassettiere e scrivanie, permettono di creare la forma e la dimensione desiderata. Gli elementi sono disponibili in tre altezze 704 mm, 900 mm, 1070 mm così da assolvere a più funzioni; rispettivamente per il consulto, per l'accesso alle persone con disabilità e per la funzione reception.

The Sistema concept allows you to furnish the reception space in a personalized way, thanks to the modularity of the many elements that compose it. Side and central closing panels, side or central containers, Internal and external container corner, together with shelves, drawer units and desks, allow you to create the desired shape and size. The elements are available in three heights 704 mm, 900 mm, 1070 mm so as to perform several functions; respectively for consultation, for access to people with disabilities and for the reception function.

Le concept Sistema permet d'aménager l'espace de réception de manière personnalisée, grâce à la modularité des nombreux éléments qui le composent. Les panneaux de fermeture latéraux et centraux, les conteneurs latéraux ou centraux, les coins internes et externes des conteneurs, ainsi que les étagères, les blocs-tiroirs et les bureaux, vous permettent de créer la forme et la taille souhaitées. Les éléments sont disponibles en trois hauteurs 704 mm, 900 mm, 1070 mm afin de remplir plusieurs fonctions ; respectivement pour la consultation, pour l'accès aux personnes handicapées et pour la fonction d'accueil.



111

Klint Trapuntato - Divano / Sofa /
Canapé:
Tessuto C49F

Bancone / Counter / Compteur:
M788 Visone
M953 Noce Mat





Bancone / Counter / Compteur:
F150 Brown
M840 Corten Berico

SISTEMA

WALCO

LOGICA

116 **Pareti divisorie** Walco propone, per la divisione dello spazio ufficio, una moderna e funzionale collezione di robuste pareti divisorie e attrezzate, facilmente integrabili a pavimenti, pavimenti flottanti, soffitti, controsoffitti e muri perimetrali.

Partition walls To divide open office spaces, our Company proposes a modern, functional collection of study partitions and equipped panels that can be easily fixed to floors, floating floors, ceilings, false ceilings and perimeter walls.

Parois de séparation Walco propose, pour la division de l'espace de travail, une moderne et fonctionnelle collection de parois de séparation robustes et équipées, qui peuvent facilement être intégrées aux planchers, aux planchers flottants, aux plafonds et fauxplafonds et aux murs périmétraux.





Le finestre delle pareti divisorie sono in realtà il risultato di due semi-finestre contrapposte. Nel punto di contatto sono presenti due guarnizioni a palloncino, che garantiscono l'ermeticità del prodotto composito. A richiesta è possibile montare tra le due semi-finestre, delle tende veneziane a lamelle da 25 mm, con comando orientabile manuale.

The windows of the partition walls are actually the result of two opposite half-windows. At the contact point there are two balloon shaped seals, which guarantee the hermetic seal of the composite product. On request, it is possible to mount Venetian blinds with 25 mm slats between the two half-windows, with manual adjustable control.

Les fenêtres des cloisons sont en fait le résultat de deux demi-fenêtres opposées. Au point de contact, il y a deux joints à ballonnet, qui garantissent l'étanchéité du produit composite. Sur demande, il est possible de monter des stores vénitiens à lames de 25 mm entre les deux demi-fenêtres, avec commande manuelle réglable.



120

121

La trasparenza è parte integrante della nostra cultura aziendale. L'ufficio "in chiaro" rappresenta un valore aggiunto all'ambiente di lavoro favorendo infatti la comunicazione, l'armonia e l'operosità fra le persone del collettivo che vi opera.

Transparency is not only a competitive value, it is also an integral part of our company culture. The "see-through" office is an added value for the environment as it encourages communication, harmony and a positive work attitude among the people sharing the office space.

La transparence, est un élément essentiel de notre culture d'entreprise. Le bureau "en clair" représente une valeur ajoutée au lieu de travail en favorisant en effet la communication, l'harmonie et l'activité entre les personnes du groupe qui y travaille.





124

125

LOGICA

WALCO

Sono disponibili a richiesta ripiani metallici realizzati in lamiera piegata verniciata grigia, predisposti nella parte sottostante per l'aggancio delle cartelle sospese con interasse 330 mm a lettura orizzontale.

On request metal shelves are available in bent sheet metal, painted grey. Undemeath they are prepared for holding suspended folders with a 330 mm vertical interaxis.

Sur demande, il est également possible d'obtenir des étagères métalliques réalisées en tôle pliée peinte en gris, prévues dans la partie inférieure pour l'accrochage des dossiers suspendus avec un entraxe de 330 mm à lecture verticale.



126

LOGICA



127



WALCO



Tecnica

Technique

Technique

130

132	Contenitori	Storage units	Conteneurs
132	- Ark	- Ark	- Ark
134	- Ark light	- Ark light	- Ark light
136	- Ark scorrevole	- Ark sliding	- Ark coulissante
138	- Lockers	- Lockers	- Lockers
139	Materiali	Materials	Matériaux
142	Maniglie	Handles	Poignées

131

Ark

Contenitori / Storage units / Conteneurs

Il sistema di mobili contenitori Ark è pensato per dare la massima libertà compositiva. Sono disponibili in differenti altezze (6 con sopralzo da 768) e due larghezze. Ark può essere personalizzato anche nel colore della scocca e dei frontali.

La struttura e le ante sono realizzate con spessore di 18 mm, mentre all'interno lo spessore dei ripiani è di 25 mm.

The Ark storage system is designed to give maximum compositional freedom. They are available in different heights (6 with 768 hanging unit) and two widths. Ark can also be customized in the color of the structure and the fronts.

The perimeter structure and the doors are made with a thickness of 18mm, while the back measures 18mm thick and the shelves inside 25mm.

Le système de stockage Ark est conçu pour offrir une liberté de composition maximale. Ils sont disponibles en différentes hauteurs (6 avec 768 au-dessus) et deux largeurs. Ark peut également être personnalisé dans la couleur du corps et des façades.

La structure périmétrique et les portes ont une épaisseur de 18 mm, tandis que le dos mesure 18 mm d'épaisseur et les étagères à l'intérieur 25 mm.

Schiena: sp. 18 mm
Scocca*: 22 colori
Frontali: 22 colori nobilitati
 13 Colori laccati
 Lucidi e opachi
 Vetro fumè temperato

* A richiesta con scocca laccata opaca e lucida.

**Massima libertà compositiva.
 Grande resistenza.
 Ante nobilitate con cerniera rallentata.**

Back: th. 18 Mm
Structure*: 22 colours
Fronts: 22 melamine colours
 13 glossy and matt
 Laquered colours
 Smoked tempered glass

* On request with matt and glossy lacquered structure.

**Maximum compositive freedom
 great resistance.
 Melamine doors with slow closing hinges.**

Dossier: ép. 18 Mm
Structure*: 22 couleurs
Façades: 22 couleurs anoblies
 13 Couleurs laquées
 Brillantes et opaques
 Verre trempé fumé

* Sur demande avec structure laquée mate et brillante.

**Liberté maximale en composition
 Grande résistance.
 Portes anoblies avec charnière ralentie.**

132



788



1172



1556



1940



2324



2708



P. 468

133

ARK

WALCO

20
0

Ark light

Contentori / Storage units / Conteneurs

Semplicità e funzionalità sono le caratteristiche che distinguono il sistema di mobili contenitori Ark Light. Progettati per ottimizzare al massimo l'archiviazione dei documenti e del materiale, tutti i moduli che compongono la linea sono affiancabili. Mentre la scocca può essere scelta nelle tinte bianco grigio e grafite, le ante a battente sono disponibili in tanti colori. La struttura perimetrale in due profondità e le ante sono realizzate con spessore di 18 mm, mentre la schiena misura 5 mm di spessore e i ripiani all'interno 25 mm.

Simplicity and functionality are the characteristics that distinguish the Ark Light storage system. Designed to maximize the storage of documents and material, all modules that make up the line can be placed side by side. While the structure can be chosen in white, gray and graphite, the hinged doors are available in many colors. The perimeter structure in two depths and the doors are made with a thickness of 18mm, while the back measures 5mm thick and the shelves inside 25mm.

La simplicité et la fonctionnalité sont les caractéristiques qui distinguent le système de rangement Ark Light. Conçus pour optimiser le rangement des documents et du matériel, les modules qui composent la ligne peuvent être placés côte à côte. Tandis que la coque peut être choisie en blanc, gris et graphite, les portes battantes sont disponibles dans de nombreuses couleurs. La structure périmétrique en deux profondeurs et les portes sont réalisées avec une épaisseur de 18 mm, tandis que le dos mesure 5 mm d'épaisseur et les étagères à l'intérieur 25 mm.

Schiena: sp. 5 mm
Scocca*: M001 bianca
M700 grigia
M790 grafite

Frontali: 22 colori nobilitati
13 Colori laccati
Lucidi e opachi
Vetro trasparente
temperato

* A richiesta con scocca laccata opaca e lucida.

Grande componibilità grazie alle due profondità.
Facile e rapido da montare.
Ante nobilitate con cerniera rallentata.

Back: th. 5mm
Structure*: M001 white
M700 grey
M790 graphite

Fronts: 22 melamine colours
13 glossy and matt
Lacquered colours
Transparent tempered
glass

* On request with matt and glossy lacquered structure.

Great modularity thanks to the two depths.
Quick and easy to assemble.
Melamine doors with slow closing hinges.

Dossier: ép. 5mm
Structure*: M001 blanc
M700 gris
M790 graphite

Façades: 22 couleurs anoblies
13 Couleurs laquées
Brillantes et opaques
Verre trempé
transparent

* Sur demande avec structure laquée mate et brillante.

Grande modularité grâce aux deux profondeurs.
Assemblage facile et rapide.
Portes anoblies avec charnière ralentie.

134



■ Solo in P. 468 / Only D. 468 / Seulement dans P. 468

ARK LIGHT

WALCO

20
0

P.372
P. 468

135

Ark scorrevole

Contentori / Storage units / Conteneurs

Le ante scorrevoli interne conferiscono al sistema di mobili contenitori Ark Scorrevole grande praticità ed ergonomia, perfetti in ambienti più ristretti, dove le ante scorrevoli possono essere aperte e chiuse senza ingombrare. Il sistema è presentato in 2 moduli da 4 altezze, tutti affiancabili.

La struttura e le ante sono realizzate con spessore di 18 mm, mentre all'interno lo spessore dei ripiani è di 25 mm.

The internal sliding doors give the sliding Ark storage system great practicality and ergonomics, perfect in smaller environments, where the sliding doors can be opened and closed without cluttering. The system is presented in 2 modules of 4 heights, all side by side.

The perimeter structure and the doors are made with a thickness of 18mm, while the back measures 18mm thick and the shelves inside 25mm.

Les portes coulissantes internes confèrent au système de rangement Ark Coulissante une grande praticité et ergonomie, parfaites dans les petits environnements, où les portes coulissantes peuvent être ouvertes et fermées sans encombrement. Le système se présente en 2 modules de 4 hauteurs, tous côte à côte.

La structure périmétrique et les portes ont une épaisseur de 18 mm, tandis que le dos mesure 18 mm d'épaisseur et les étagères à l'intérieur 25 mm.

Schiena: sp. 18 mm
Scocca*: 22 colori

Frontali e cappello:
22 Colori nobilitati
13 Colori laccati
Lucidi e opachi

* A richiesta con scocca laccata opaca e lucida.

Facile e rapido da montare.
Salvaspazio.

Back: th. 18 Mm
Structure*: 22 colours

Fronts and upper shelf:
22 Melamine colours
13 Glossy and matt
Lacquered colours

* On request with matt and glossy lacquered structure.

Quick and easy to assemble.
Space saving.

Dossier: ép. 18 Mm
Structure*: 22 couleurs

Façades et plafond:
22 Couleurs anoblies
13 Couleurs laquées
Brillantes et opaques

* Sur demande avec structure laquée mate et brillante.

Assemblage facile et rapide.
Peu encombrant.

136



137



Lockers

Nati per soddisfare le esigenze degli spazi di lavoro con grande mobilità e dinamismo, questi Lockers sono armadi a scomparti con serratura, pensati per poter mettere in sicurezza gli effetti personali di piccole dimensioni, come borse, zaini, caschi.

Schiena: sp. 18 mm
Scocca*: 22 colori

Frontali e cappello:
22 Colori nobilitati
13 Colori laccati
Lucidi e opachi

* A richiesta con scocca laccata opaca e lucida

Born to meet the needs of work spaces with great mobility and dynamism, these Lockers are wardrobes with lockable compartments, designed to be able to secure small personal effects, such as bags, backpacks, helmets.

Back: th. 18mm
Structure*: 22 colours

Fronts and upper shelf:
22 Melamine colours
13 Glossy and matt
Lacquered colours

* On request with matt and glossy lacquered structure

Nés pour répondre aux besoins des espaces de travail avec une grande mobilité et dynamisme, ces casiers sont des compartiments verrouillables, conçus pour pouvoir sécuriser de petits effets personnels, tels que des sacs, des sacs à dos, des casques.

Dossier: ép. 18mm
Structure*: 22 couleurs

Façades et plafond:
22 Couleurs anoblies
13 Couleurs laquées
Brillantes et opaques

* Sur demande avec structure laquée mate et brillante

* Con top sp. 18 mm
* With 18 mm thick top
* Avec haut sp. 18 mm

P. 468



20
0

Materiali

Materials / Matériaux

Melaminico
Melamine
Mélaminé



M001 Bianco

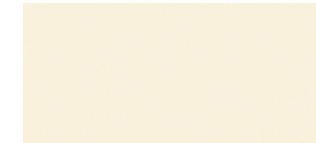

M011 Corda



M784 Canapa (NEW)



M788 Visone (NEW)

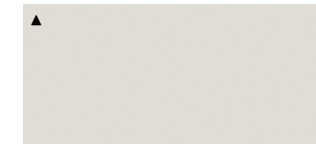

M700 Grigio

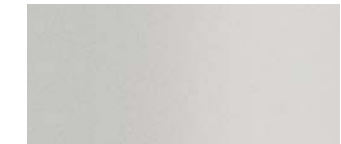

M750 Irony

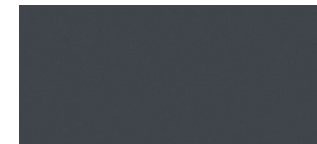

M782 Antracite



M790 Grafite (NEW)



M610 Avio (NEW)



M943 Frassino Nuvola (NEW)



M965 Rovere Rigato



M955 Rovere Maine



M927 Rovere Gessato



M912 Noce Eden

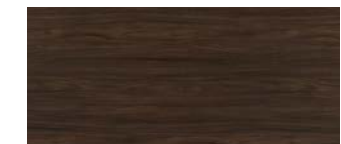

M960 Noce Moka



M953 Noce Mat (NEW)



M947 Noce Smoke (NEW)

▲ Scocca disponibile per / Structure available for / Structure disponible pour **Ark Light**.

Le finiture ed i colori qui riportati devono ritenersi puramente indicativi. Per una visione realistica ed aggiornata consultare il nostro campionario colori. / Finishes and colours shown here are merely indicative. Please see our colour sample book for a more realistic and updated image. / Les finitions et les couleurs sont présentées à titre purement indicatif. Pour un rendu réel et actualisée, consulter nos échantillons de couleurs.

Materiali

Materials / Matériaux

Melaminico Melamine Mélaminé

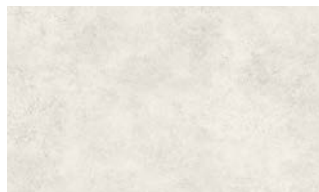

M980 Calce Perla



M990 Calce Cenere



M840 Corten berico



M831 Marmo Canova (NEW)



M839 Marmo nero Marquinia (NEW)

Vetri retrolaccati

Back-painted glasses
Verres peintes au dos



V003 Vetro Bianco



V430 Vetro Grigio Caldo



V106 Vetro Beige



V150 Vetro Brown



V095 Vetro Nero Intenso



V430 Vetro Rosso Rubino



V095 Vetro Fumè



V150 Vetro Acidato



Vetro Trasparente

Le finiture ed i colori qui riportati devono ritenersi puramente indicativi. Per una visione realistica ed aggiornata consultare il nostro campionario colori. / Finishes and colours shown here are merely indicative. Please see our colour sample book for a more realistic and updated image. / Les finitions et les couleurs sont présentées à titre purement indicatif. Pour un rendu réel et actualisée, consulter nos échantillons de couleurs.

Laccati goffrato fine opaco o lucido spazzolato Fine embossed matt or brushed glossy lacquer Laque mate gaufrée ou brillante brossée



F220 Giallo Sole K220



F132 Odra K132



F430 Rosso Rubino K430



F590 Pavone K590



F660 Polvere K660



F680 Oceano K680



F550 Verde Siria K550

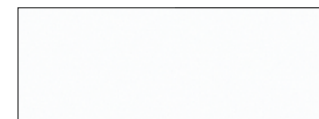

F003 Bianco K003

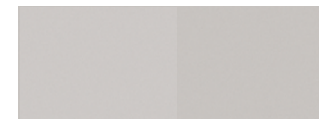

F052 Ghiaia K052



F075 Grigio Caldo K075



F106 Beige K106



F150 Brown K150



F095 Nero Intenso K095

Metalli (gambe)

Metals (legs)
Métaux (jambes)



Bianco



Nero



Grigio



Odra

Le finiture ed i colori qui riportati devono ritenersi puramente indicativi. Per una visione realistica ed aggiornata consultare il nostro campionario colori. / Finishes and colours shown here are merely indicative. Please see our colour sample book for a more realistic and updated image. / Les finitions et les couleurs sont présentées à titre purement indicatif. Pour un rendu réel et actualisée, consulter nos échantillons de couleurs.

Maniglie

Handles / Poignées

MANIGLIE STANDARD

STANDARD HANDLES / POIGNÉES STANDARDS

				DIMENSIONI SIZES DIMENSIONS	PASSO STEP ÉTAPE
		TIPO "W" in materiale plastico made of plastic en matière plastique	 RAL9006 GRIGIO grey - gris	L 174 H 10 P 22	160
		TIPO "X" in materiale plastico made of plastic en matière plastique	 RAL9006 GRIGIO grey - gris	L 214 H 16 P 27	160
		TIPO "E" in materiale plastico made of plastic en matière plastique	 BIANCO white - blanc  NERO black - noir  MARRONE brown - marron	L 206 H 29 P 19	160
		TIPO "Q" * in metallo made of metal en métal	 RAL9006 GRIGIO grey - gris	L 230 H 25 P 29	160
		TIPO "C" in metallo made of metal en métal	 CROMO chromed - chrome  SATINATO satinéd - satiné  BIANCO white - blanc  NERO black - noir	L 171 H 11 P 24	160
		TIPO "S" in alluminio made of aluminum en aluminium	 ALLUMINIO aluminum - aluminium	L 200 H 20 P 25	160
		TIPO "L" in metallo made of metal en métal	 NERO black - noir  BIANCO white - blanc	L 210 H 18 P 16	160

*Non applicabile su contenitori con serratura / Not applicable on storage units with lock / Pas applicable sur les rangement avec serrure.

MANIGLIE / HANDLES / POIGNÉES

TIPO "W"
in materiale plastico
made of plastic
en matière plastique



TIPO "X"
in materiale plastico
made of plastic
en matière plastique



TIPO "E"
in materiale plastico
made of plastic
en matière plastique



TIPO "Q" *
in metallo
made of metal
en métal



TIPO "C"
in metallo
made of metal
en métal



TIPO "S"
in alluminio
made of aluminum
en aluminium



TIPO "L"
in metallo
made of metal
en métal



MONTAGGIO SOLO ORIZZONTALE (escluso scorrevoli)
Nel caso di richieste personalizzate l'Azienda fornirà i frontali senza fori maniglia. La foratura dovrà essere eseguita dal cliente in cantiere. Conseguenti errori di foratura non daranno seguito alla sostituzione dei frontali in garanzia.

HORIZONTAL ASSEMBLY ONLY (excluding sliding doors)
If specifically requested, the Company will provide fronts without handle holes. The holes must be drilled by the customer on site. Any errors caused by drilling will not entitle the fronts to be replaced under guarantee.

MONTAGE UNIQUEMENT HORIZONTAL (exclus coulissants)
En de cas de requête personnalisée, la Société fournira les façades sans trous poignées. Le perçage devra être exécuté par le propre client, sur son chantier. De conséquents erreurs de perçage ne donneront en aucun cas droit à la substitution des façades sous garantie.

*Non applicabile su contenitori con serratura / Not applicable on storage units with lock / Pas applicable sur les rangement avec serrure.

WALCO

Walco spa

Via dei Cavalli, 9
31030 Cison di Valmarino (TV) - Italy
T. +39 0438 975 666
F. +39 0438 975 656
walco@walco-office.it

www.walco-office.it

WALCO
OFFICE FURNITURE



WALCO
OFFICE FURNITURE